



Front dimensions: \varnothing 28 mm
Panel cut-out: \varnothing 22.3 mm
Front bezel height: 2 mm
Travel: 2.3 mm / 1.8 mm



SHORTRON

 Product configurator



Overview - SHORTRON series

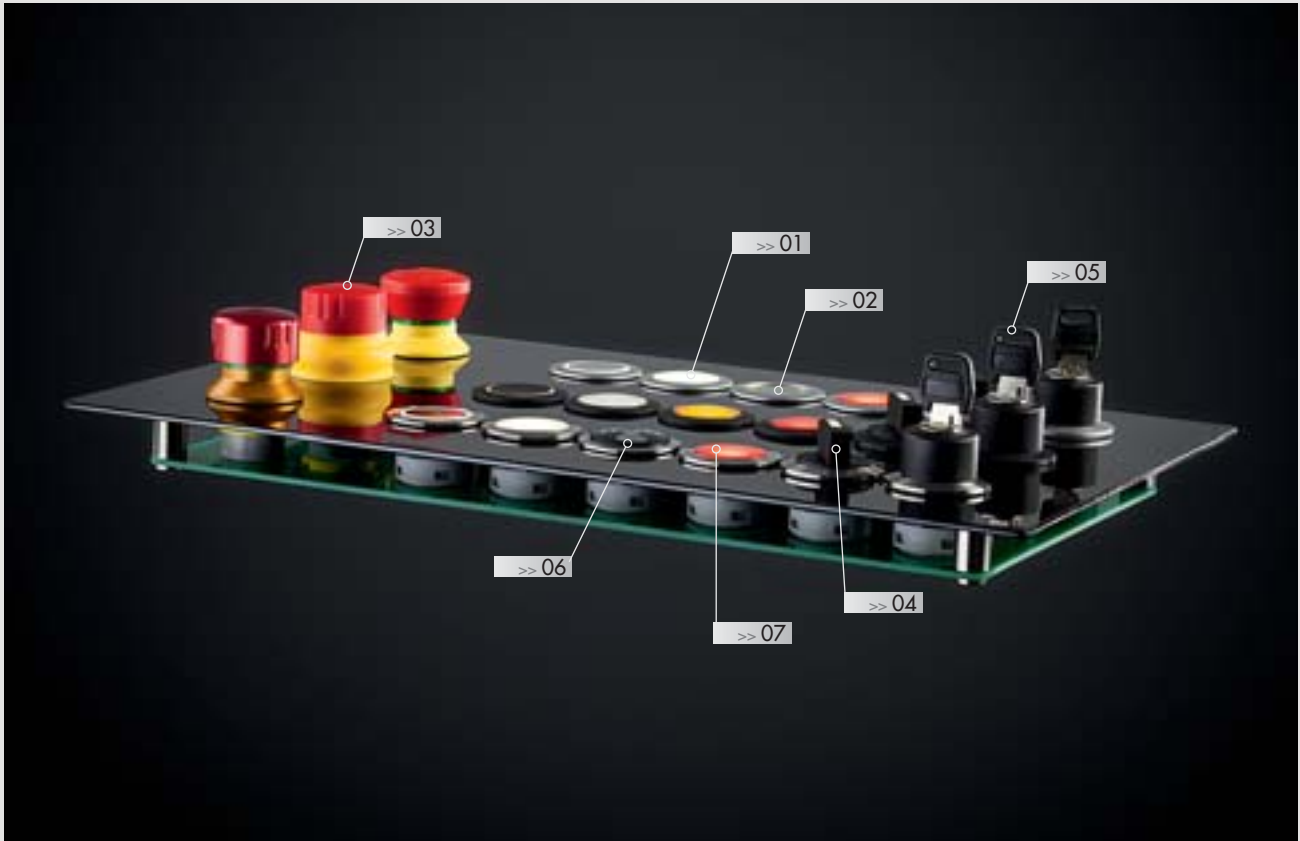

01 Pushbuttons	page 134	06 Pilot lights	page 155
Tactile pushbuttons	page 135		
02 Emergency-stop buttons	page 141		
03 Selector switches	page 147		
04 Key switches	page 152		
05 Buzzers	page 155		

Housing colours (silver-coloured, black, polished stainless steel)



degree of protection



operating travel



tactile



illuminating option



labelling option



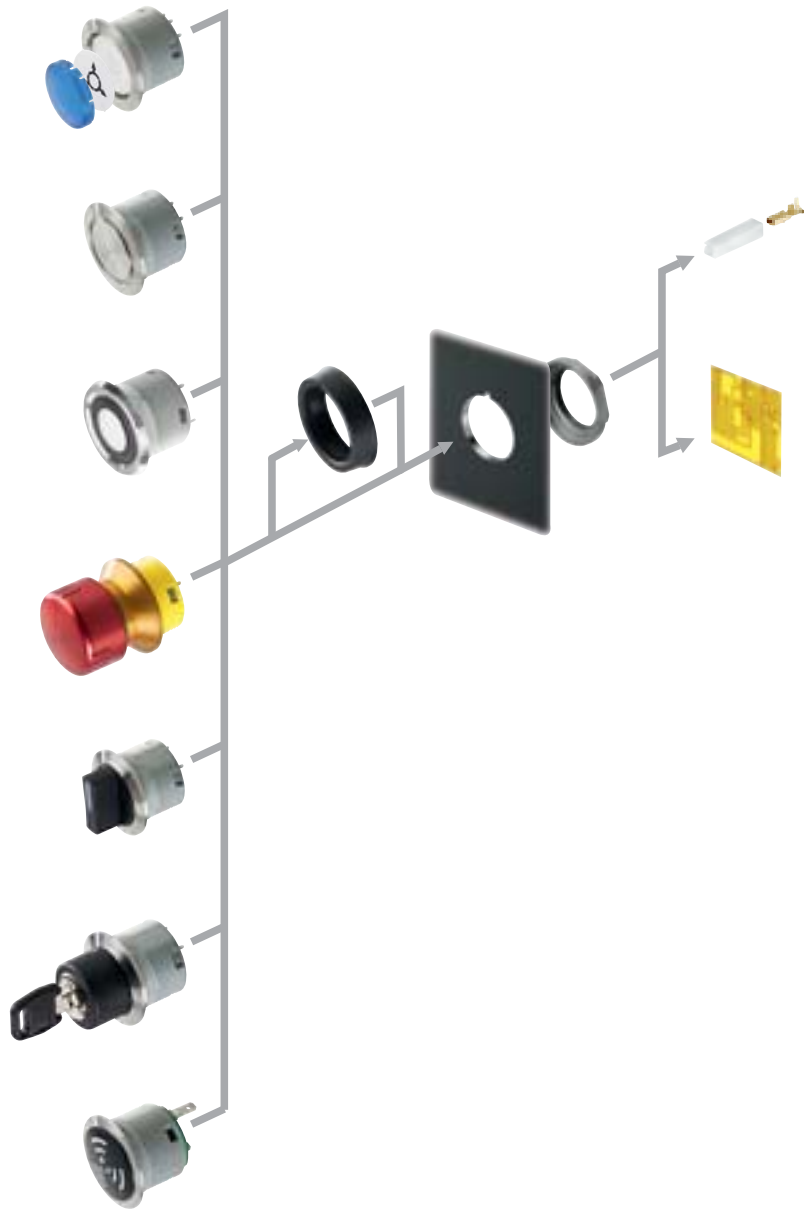

Mounting Faston Clamp 2.8x0.8mm



Mounting depth dimensions

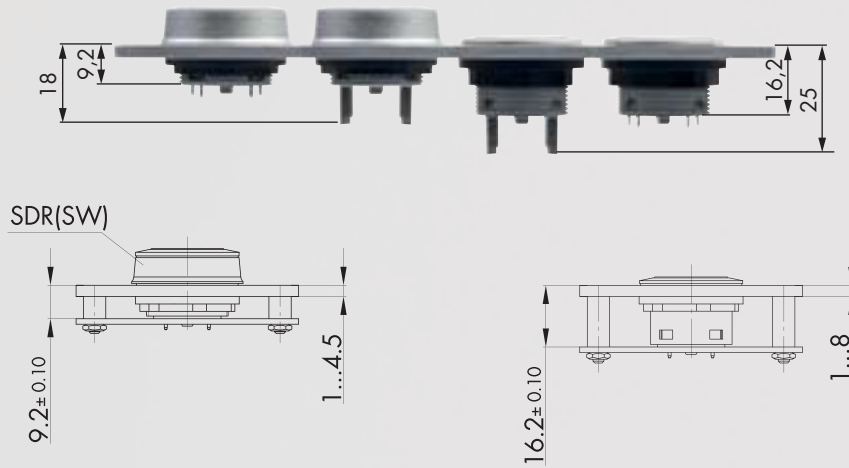

Cutout dimensions

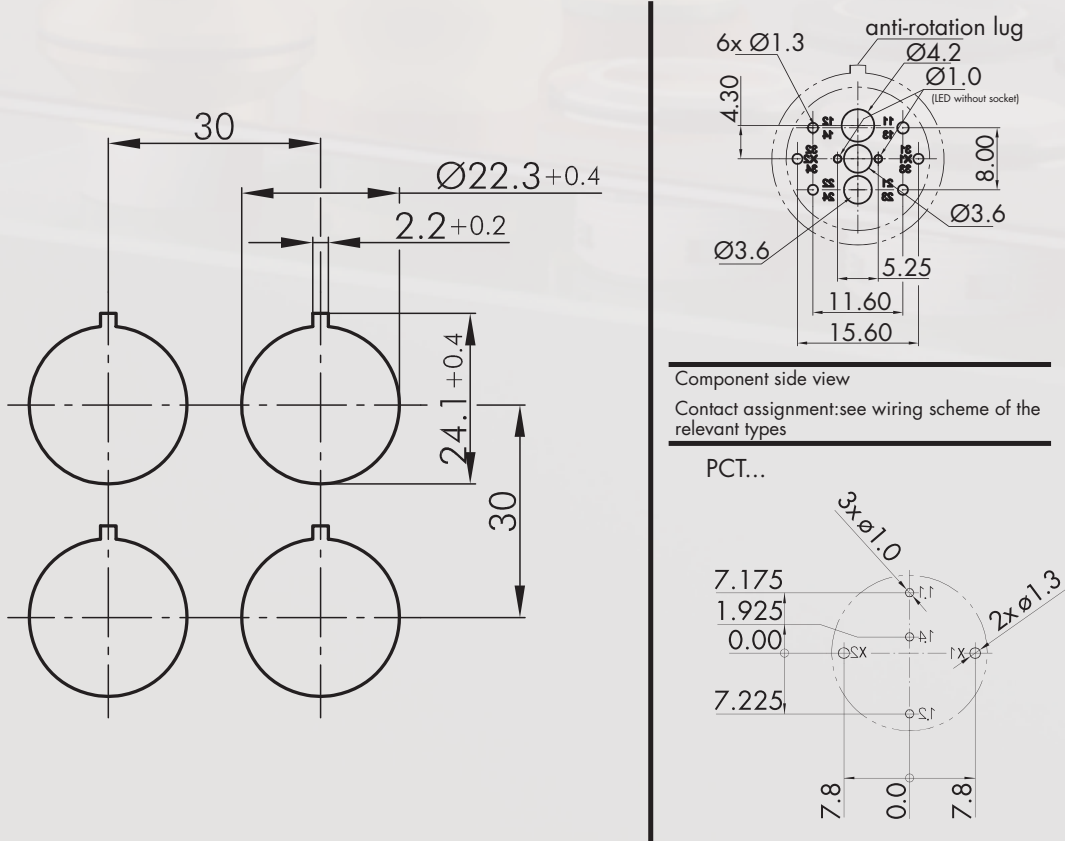

General Data

Type reference: FR(P)VK(Y1)(P)(L)(R)(O)(OO)(OI)(S)(OOO)(OOI)(OII)(Z)(LZ)(P)(L)AU(LR0)
 Description: Emergency-stop head, foolproof
 Approvals: CCC, CE, cURus, DGUV_Test, TÜV_Süd
 Contact type: 1NC / 2NC / 3 NC / 1 NC+1NO / 2NC+1NO / 1NC+2NO
 Degree of protection: IP65 / IP67
 Connection type: Faston terminals 2.8x0.8 mm / PCB-mount terminals
 Contact material: AgNi / AgNi, gold-plated 5µm (L)AU
 Max. storage temperature: -40°C ... 80°C
 Max. operating temperature: -25°C ... 70°C
 Mechanical life: 50.000
 Electrical life (rated load): 50.000 at rated load
 Contact resistance NO: < 50 mOhm (new state)
 Contact resistance NC: < 50 mOhm (new state)
 Bouncing time NC: < 10ms
 Positive opening contact: acc. to EN60947-5-1, appendix K

Electrical data acc. to IEC/EN 60947-5-1 (VDE 0660 Sect. 200)

Utilisation category:	alternate current	direct current
Rated insulation voltage Ui:	AC15 B300	DC13 Q300
Rated operating voltage Ue:	250 V	250 V
Rated operating current Ie:	240 V / 120 V	250 V / 125 V / 60 V / 24 V
Breaking capacity:	1.5 A / 3 A	0.27 A / 0.55 A / 1 A / 2 A
Continuous thermal current:	10Ie	1, 1Ie
	5 A	

Technical Data - Lamp

Lamp socket: none, with integrated 3 mm LED
 Max. lamp voltage: 30 V AC/DC
 Max. lamp output: 4 mA at 24 V DC)
 Definition: X1...anode, X2...cathode

Additional data

Mounting aperture: 22.3 mm
 Tightening torque (mounting nut): 1.3 ... 1.9 Nm
 Release: twist release, left or right
 Mounting position: any
 Standards: EN 60947-5-1, EN 60947-5-5, EN ISO 13850
 Ld: 20% (NC)
 B10d: 250.000
 Pollution degree : 3

Note

O = NC contact; I = NO contact
 With switching position indicator

Electrical features for 5µm gold-plating, type addition ...AU

Switching voltage: 20mV ... 42V AC/DC
 Switching current: 1mA ... 250mA
 Versions with Faston terminals: use partially or all-insulated Faston clamps

Overtoltage category II (2.5kV), pollution degree 2 for:

- illuminated versions (24 V LED)
- versions with 3rd contact
- versions with NO contacts (I, II, OI)

FRVKP... emergency-stop for hygienic areas
 Tightening torque (fixing nut): 1.0 ... 1.7 Nm
 Degree of protection: IP66/IP67/IP69k* 1)
 Approvals: CE, DGUV-Test
 Mechanical life: 20.000 (20°C)
 >6050 (-25°C)
 >6050 (+70°C)
 B10d/Ld: 150.000
 * 1) Limitation: nozzle distance > 250 mm. Standard requirement acc. to ISO 20653:2013-02 (IPX9K) 100 - 150 mm

Use in hygienic areas:

- Permanently suitable from -30°C to +50°C and with food contact temporarily up to +70°C
 - Migration testing (OML) according to EU regulation no.10/2011 using ethanol (50%) and acetic acid (3%) at 40°C/1h, ethanol (95%) at 40°C/0.5h
 - The emergency stop should be installed in a way to exclude a deposit of residues in its active and non-active state
- FRVK...Z ...emergency-stop for base-plate mounting
 FRVK...LZ ...emergency-stop for base-plate mounting with height compensation for Shortron

Approvals: CE

About Us

→ Pushbuttons and Switches

Panel Mount Jacks

Emergency-Stop Buttons

Bus Technology

RFID

Enclosures

Pedal Switches

Terminal Blocks

Type Index

Ø 22.3 mm

About Us

→ Pushbuttons and Switches

Panel Mount Jacks

Emergency-Stop Buttons

Bus Technology

RFD

Enclosures

Pedal Switches

Terminal Blocks

Type Index

The relating contact block (PTS...) is being plugged into the neck of the actuator head. Spacer sleeves ensure the correct distance between PCB and mounting plate. The screws must be secured against loosening.

FRVK...R... ...red LED
FRVK...RO ...0 ohm series resistor, with protective diode (series-connected)
Attention: The LED must not be operated without series resistor.
(Do not connect terminals X1-X2 directly to voltage)

Observe LED data!
LED cut-off voltage: max. 70 V (with protective diode)
If LED, max: 30 mA
Uf LED, typical: white: 3.2V (20mA) red: 2.0 V (20mA)
FRPVK... FRPVK(Z), FRPVK(O)(OO)(OI)(LOO) FRPVK(OO)(OO)P
Release: pull to release
Max. traction: 160N
Life time: 30.000
B10d/Ld: 170.000/20%
Data acc. to UL
Rating contact block: Silver: B300, 24V DC/3A Gold: 42V DC/100mA
Lamp rating: LED: 30 Vac/Dc (4 mA at 24 V)
NEMA TYPE: 4x indoor (front face)
Operating temperature: 10°C...40°C

General Data

Type reference: FRVKAL(O)(OO)(OOO)(OI)(OOI)(OII)(P)(Z)(LZ)(_AU)(_RO)
Description: Emergency-stop head, aluminium version, foolproof
Approvals: CCC, CE, cURus, TÜV_Süd
Contact type: 1NC / 2NC / 3 NC / 1 NC+1NO / 2NC+1NO / 1NC+2NO
Degree of protection: IP65 / IP67
Connection type: Faston terminals 2.8x0.8 mm / PCB-mount terminals
Contact material: AgNi / AgNi, gold-plated 5µm (_AU)
Max. storage temperature: -40°C ... 80°C
Max. operating temperature: -25°C ... 70°C
Mechanical life: 50.000
Electrical life (rated load): 50.000 at rated load
Contact resistance NO: < 50 mOhm (new state)
Contact resistance NC: < 50 mOhm (new state)
Bouncing time NC: < 10ms
Positive opening contact: acc. to EN60947-5-1, appendix K

Electrical data acc. to IEC/EN 60947-5-1 (VDE 0660 Sect. 200)

	alternate current	direct current
Utilisation category:	AC15 B300	DC13 Q300
Rated insulation voltage Ui:	250 V	250 V
Rated operating voltage Ue:	240 V / 120 V	250 V / 125 V / 60 V / 24 V
Rated operating current Ie:	1.5 A / 3 A	0.27 A / 0.55 A / 1 A / 2 A
Breaking capacity:	10Ie	1, 1Ie
Continuous thermal current:	5 A	

Additional data

Mounting aperture: 22.3 mm
Tightening torque (mounting nut): 1.3 ... 1.9 Nm
Release: twist release, left or right
Mounting position: any
Standards: EN 60947-5-1, EN 60947-5-5, EN ISO 13850
Pollution degree : 3

Reliability data

Ld: 20% (NC)
B10d: 250.000

Note

O = NC contact; I = NO contact
With switching position indicator

Electrical features for 5µm gold-plating, type addition ...AU

Switching voltage: 20mV ... 42V AC/DC
Switching current: 1mA ... 250mA
Versions with Faston terminals: use partially or all-insulated Faston clamps
Versions with 3 contacts: overvoltage category II (2.5kV), pollution degree 2

Data acc. to UL
Rating contact block: Silver: B300, 24V DC/3A Gold: 42V DC/100mA
Lamp rating: LED: 30 Vac/Dc (4 mA at 24 V)
NEMA TYPE: 4x indoor (front face)

General Data

Type reference:	S(VA)(SW)(T)(TLR _x)(WA)(WB)(SSA...)(N)(STA)(STB)(L)(x)(I)(II)(O)(OO)(OI)(P)(L)AU
Description:	Pushbuttons and switches, flat/raised version, with faston/PCB connection
Approvals:	CCC, CE, cURus, DNVGL, ENEC10, VDE, CE
Contact type:	2NC / 1NC+1NO / 2 NO / 1NO / 1NC
Degree of protection:	IP65 / IP67 (T, TLR, N) IP65 (SSA, STA, STB, WA, WB)
Operation travel:	2.3 mm
Connection type:	Faston terminals 2.8x0.8 mm / PCB-mount terminals
Max. storage temperature:	-40°C ... 80°C
Max. operating temperature:	-25°C ... 70°C
Mechanical life:	1 million sw.-cycl. (T,TLR) 30.000(WA,WB,STA,SSA)
Electrical life (rated load):	1 million switching cycles (T,TLR) 30.000(WA,WB,STA,SSA)
Contact resistance NO:	< 20 mOhm
Contact resistance NC:	< 20 mOhm
Min. current:	1 mA (under laboratory conditions)
Min. voltage:	5 V
Bouncing time NC:	< 10ms
Positive opening contact:	acc. to EN60947-5-1, appendix K

Electrical data acc. to IEC/EN 60947-5-1 (VDE 0660 Sect. 200)

Utilisation category:	alternate current AC15 B300	direct current DC13 Q300
Rated insulation voltage Ui:	250 V	250 V
Rated operating voltage Ue:	240 V / 120 V	250 V / 125 V / 60 V / 24 V
Rated operating current Ie:	1.5 A / 3 A	0.27 A / 0.55 A / 1 A / 2 A
Breaking capacity:	10Ie	1,1Ie
Continuous thermal current:	5 A	

Electrical data acc. to IEC/EN 61058-1 (VDE 0630 Sect. 1)

Rated voltage Ue:	250 V~
Rated current Ie:	6(4) A

Technical Data - Lamp

Lamp socket:	none, with integrated 3 mm LED white
Max. lamp voltage:	30 V AC/DC
Max. lamp output:	14 mA (at 24 V DC)
Definition:	X1...anode, X2...cathode

Additional data

Mounting aperture:	22.3 mm
Tightening torque (mounting nut):	1.5 ... 1.9 Nm
Mounting position:	any
Standards:	EN 60947-5-1, EN 61058-1

Electrical features - 5µm gold-plating, type addition ...AU

Operational voltage:	20mV ... 42V AC/DC
Switching current:	1mA ... 100mA
Contact resistance (new state):	< 50 mOhm

Note

- O = NC contact; I= NO contact
- T...pushbutton
- TLR(x)...pushbutton with LED ring (x=colour: W,R,Y,G,B)*2
- N...pilot light
- SSA...key actuator
- STA, STB...selector switch momentary
- WA, WB...selector switch maintained
- Basic version with Faston terminals 2.8x0.8mm
- (P) = type with PCB-mount terminals
- DC13: > 100.000 switching cycles
- Versions with Faston terminals: use partially or all-insulated Faston clamps

Overvoltage category II (2.5kV), pollution degree 2 for:

- illuminated versions (24 V LED)
- versions with 3rd contact
- versions with NO contacts (I, II, OI)

This data sheet is not applicable for the types "S..C.." (tactile versions of the Shortron range)

*2 with ring illumination

About Us

→ Pushbuttons and Switches

Panel Mount Jacks

Emergency-Stop Buttons

Bus Technology

RFID

Enclosures

Pedal Switches

Terminal Blocks

Type Index

General Data

Type reference:	FRVKD(O)(OO)(OI)(P)(L)AU
Description:	Emergency-stop, active/inactive (without diagnostic device)
Approvals:	CE, cURus, TÜV_Süd
Contact type:	1NC/2NC/1NC+1NO
Degree of protection:	IP65 / IP67
Connection type:	Faston terminals 2.8x0.8 mm / PCB-mount terminals
Contact material:	AgNi / AgNi, gold-plated 5µm (L)AU
Max. storage temperature:	-40°C ... 80°C
Max. operating temperature:	-25°C ... 70°C
Mechanical life:	50.000
Electrical life (rated load):	50.000 at rated load
Contact resistance NO:	< 50 mOhm (new state)
Contact resistance NC:	< 50 mOhm (new state)
Bouncing time NC:	< 10ms
Positive opening contact:	acc. to EN60947-5-1, appendix K

Electrical data acc. to IEC/EN 60947-5-1 (VDE 0660 Sect. 200)

	alternate current	direct current
Utilisation category:	AC15	DC13
Rated insulation voltage Ui:	250 V	250 V
Rated operating voltage Ue:	35 V	35 V
Rated operating current Ie:	5 A	2 A
Breaking capacity:	10Ie	1,1Ie
Continuous thermal current:	5 A	2.5 A

Technical Data - Lamp

Lamp socket:	none, with integrated 3 mm LED
Definition:	X1...anode, X2...cathode

Additional data

Mounting aperture:	22.3 mm
Tightening torque (mounting nut):	1.3 ... 1.9 Nm
Release:	twist release, left or right
Mounting position:	any
Standards:	ISO 13850:2015(E), EN ISO 13850:2015(D), DIN EN ISO 13850:2016-05
Ld:	20% (NC)
B10d:	250.000
Overvoltage category:	II
Pollution degree :	2
Material group:	I

Note

- O = NC contact; I = NO contact
- with switching position indicator
- a diagnostic unit is not included

Electrical features - 5µm gold-plating (type addition ...AU)

Switching voltage	20mV ... 35V AC/DC
Switching current	1mA ... 250mA

For the version with Faston terminals, use partially or fully insulated Faston clamps.

Illuminated version, status indication active/inactive: acc. to ISO 13850:2015(E), EN ISO 13850:2015(D), DIN EN ISO 13850:2016-05

Mushroom "grey": "inactive", no emergency-stop

Mushroom "red": "active" emergency-stop

Technical Data of LED:

Type: Opto Devices

Typical data at IF=20mA:

Luminous intensity:	min. 10,000 mcd, typical 13,000 mcd
Beam angle:	typical 15°
Dominant wavelength:	618...624 nm, typical 621 nm
Rated voltage:	24 V DC ± 10%
Rated current:	17.8 mA (15.6...19.95mA)
Typical luminous intensity at IF=18mA:	min. 9000 mcd, typical 11700 mcd
LED cut-off voltage:	max. 70V
Average life:	approx. 80,000...100,000h

Safety Instructions:

- The emergency stop must only be used when lighting conditions ensure clear and distinct visibility of the red illuminated (active) mushroom, e.g. in interiors or roofed places without direct sunlight (normal industrial environment);
- Before using the emergency stop, a systematic safety review of the overall system is required.
- Depending on the designer's risk assessment, the emergency stop lighting must be monitored by means of a "diagnostic unit", and in case of error one has to react in accordance with the risk evaluation.
- The emergency stop lighting must be checked at regular intervals to ensure its clear and distinct visibility.
- The emergency stop must be replaced if the clear visibility is no longer guaranteed.
- Please observe the operation manual

Standard compliant applications:

- pluggable operator stations
- wireless operator stations
- pluggable system components (fixed system components which are only temporarily in operation)

Data acc. to UL

Rating:

Category:

Pilot duty B300; 24Vdc/3A; Au: 42Vdc/100mA
NISD2/8

About Us

→ Pushbuttons
and Switches

Panel Mount Jacks

Emergency-Stop Buttons

Bus Technology

RFID

Enclosures

Pedal Switches

Terminal Blocks

Type Index

General Data

Type reference:	SVACFT(L)(X)(F)(P)
Description:	Single membrane pushbutton with integrated contact block, with Faston or PCB-mount terminals
Approvals:	CE, cURus, DGUV_Test, DNVGL, ENEC10, VDE, CE
Contact type:	1 inverter
Degree of protection:	IP66 / IP67 / IP69K
Operation travel:	1.8 mm
Connection type:	Faston terminals 2.8x0.8 mm / PCB-mount terminals
Max. storage temperature:	-40°C ... 80°C
Max. operating temperature:	-25°C ... 70°C
Mechanical life:	1 million switching cycles (20°C)
Contact resistance NO:	< 50 mOhm (new state)
Contact resistance NC:	< 100 mOhm (new state)
Bouncing time NC:	< 10ms

Technical Data - Lamp

Lamp socket:	none, with integrated 3 mm LED white
Max. lamp voltage:	30 V AC/DC
Max. lamp output:	14 mA (at 24 V DC)
Definition:	X1...anode, X2...cathode

Additional data

Mounting aperture:	22.3 mm
Tightening torque (mounting nut):	1.5 ... 1.9 Nm
Mounting position:	any
Standards:	EN 61058-1

Electrical features

Rated voltage:	20mV ... 48V AC/DC
Rated current:	0.01mA ... 100mA

Note

Kind of contact 1W=1 inverter	
SVACFT(L)(X)(F)(P) ()...optional	
(L) = illumination option	
(X) = colour membrane ring, standard=black (W=white, R=red, Y=yellow,G=green, B=blue)	
(F) = with Faston terminals 2.8x0.8 mm	
(P) = with PCB-mount terminals	
Data acc. to UL508	
Rating:	20mV...48V AC/DC, 0.01mA...100mA , max. 250mW

General Data

Type reference: S(VA)(SW)C(T)(TLR){...}(L){x}(F)
 Description: Tactile Short-stroke Pushbutton with integrated contact block, flat/high version, with Faston or PCB-mount terminals
 Approvals: CCC, CE, cURus, DNVGL, ENEC10, VDE, CE
 Contact type: 1 inverter
 Degree of protection: IP65 / IP67
 Operation travel: 2.3 mm
 Connection type: Faston terminals 2.8x0.8 mm / PCB-mount terminals
 Max. storage temperature: -40°C ... 80°C
 Max. operating temperature: -25°C ... 70°C
 Mechanical life: 1 million switching cycles
 Electrical life (rated load): 1 million operations
 Contact resistance NO: < 50 mOhm (new state)
 Contact resistance NC: < 100 mOhm (new state)
 Bouncing time NC: < 10ms

Technical Data - Lamp

Lamp socket: none, with integrated 3 mm LED white
 Max. lamp voltage: 30 V AC/DC
 Max. lamp output: 14 mA (at 24 V DC)
 Definition: X1...anode, X2...cathode

Additional data

Mounting aperture: 22.3 mm
 Tightening torque (mounting nut): 1.5 ... 1.9 Nm
 Mounting position: any
 Standards: EN 61058-1

Electrical features

Rated voltage: 20mV ... 48V AC/DC
 Rated current: 0.01mA ... 100mA

Note

Kind of contact 1W=1 inverter
 Basic version with PCB-mount terminals
 T(L) ...pushbutton (illumination option)
 TLR(x) ...pushbutton with LED ring (x=colour: W,R,Y,G,B)*2
 (F) ...type with Faston terminals 2.8x0.8mm
 *2 with ring illumination

Electrical data acc. to IEC/EN 60947-5-1 (VDE 0660 Sect. 200)

	alternate current	direct current
Utilisation category:	AC12	DC12
Rated insulation voltage Ui:	60V	60V
Rated operating voltage Ue:	48 V	48 V
Rated operating current Ie:	0.1 A	0.1 A
Continuous thermal current:	100 mA	100 mA

Note

GB14048.5-2008 (IEC60947-5-1)
 Data acc. to UL508
 Rating: 20mV...48V AC/DC, 0.01mA...100mA , max. 250mW

About Us

→ Pushbuttons and Switches

Panel Mount Jacks

Emergency-Stop Buttons

Bus Technology

RFID

Enclosures

Pedal Switches

Terminal Blocks

Type Index

Pushbuttons

Illustration

Dimensions

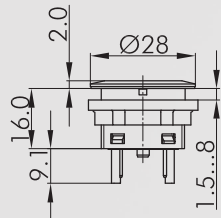

Illuminated pushbutton

incl. white LED
Faston terminals 2.8x0.8 mm

 13 14 X1 X2 0 1 2 13/14	 13 14 23 24 X1 X2 0 1 2 13/14 23/24	 11 12 23 24 X1 X2 0 1 2 11/12 23/24	
front bezel	1NO	2NO	1NC + 1NO
silver-coloured	STLI	STLII	STLOI
black	SSWTLI	SSWTLII	SSWTLOI
stainless steel, polish	SVATLI	SVATLII	SVATLOI

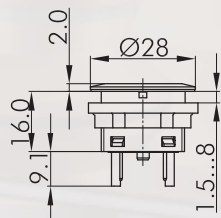

Pushbutton

Faston terminals 2.8x0.8 mm

 13 14 0 1 2 13/14	 13 14 23 24 0 1 2 13/14 23/24	 11 12 23 24 0 1 2 11/12 23/24	
front bezel	1NO	2NO	1NC + 1NO
silver-coloured	STI	STII	STOI
black	SSWTI	SSWTII	SSWTOI
stainless steel, polish	SVATI	SVATII	SVATOI

Pushbuttons

Illustration

Dimensions

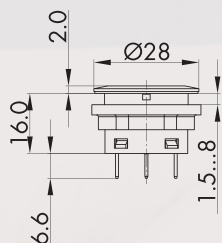

Tactile pushbutton, illuminated

incl. white LED
with gold-plated contacts
Faston terminals 2.8x0.8 mm

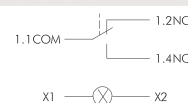

front bezel		1 inverter
silver-coloured		SCTLF
black		SSWCTLF
stainless steel, polish		SVACTLF

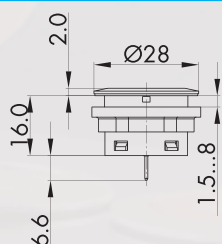

Tactile pushbutton

with gold-plated contacts
Faston terminals 2.8 mm



front bezel		1 inverter
silver-coloured		SCTF
black		SSWCTF
stainless steel, polish		SVACTF

Accessories



Flat lens, transparent

colour:	blue		T22RRBL
	yellow		T22RRGB
	green		T22RRGN
	clear		T22RRKL
	red		T22RRRT
	opal white		T22RRWS

About Us

→ Pushbuttons and Switches

Panel Mount Jacks

Emergency-Stop Buttons

Bus Technology

RFID

Enclosures

Pedal Switches

Terminal Blocks

Type Index



Accessories for Pushbuttons and Switches

Illustration

Dimensions



High lens, transparent

colour:	blue		T22HRRBL
	yellow		T22HRRGB
	green		T22HRRGN
	clear		T22HRRKL
	red		T22HRRRT
	opal white		T22HRRWS



Flat lens, non-transparent

for pushbuttons without inscription and illumination

colour:	blue		T22RRGBL
	yellow		T22RRGGB
	green		T22RRGGN
	black		T22RRGSW
	red		T22RRGRT
	white		T22RRGWS
	silver-coloured		T22RRGM

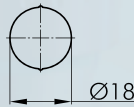

Blank nameplate

BSRRU

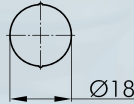

Nameplate with standard imprint

please specify index number (see nameplates from page 634)

BSRR...

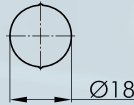

Nameplate with special imprint

according to customer's specification

BSRRB

IP67



Sealing cap

made of silicone rubber, down to -50°C

TK28S

Pushbuttons

Illustration

Dimensions

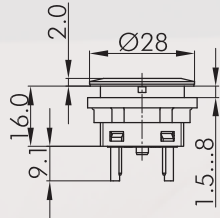

Pushbutton with ring illumination

incl. lens and white LED
Faston terminals 2.8x0.8 mm

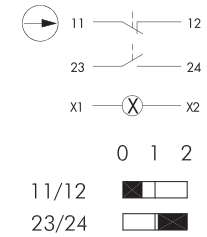
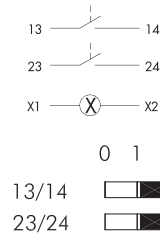
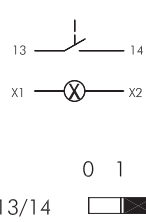

front bezel	illuminated ring	1NO	2NO	1NC + 1NO
silver-coloured	white	STLRWI	STLRWII	STLRWOI
silver-coloured	red	STLRRI	STLRRII	STLRROI
silver-coloured	green	STLRGI	STLRGII	STLRGOI
silver-coloured	yellow	STLRYI	STLRYII	STLRYOI
silver-coloured	blue	STLRBI	STLRBII	STLRBOI
black	white	SSWTLRWI	SSWTLRWII	SSWTLRWOI
black	red	SSWTLRRI	SSWTLRRII	SSWTLRROI
black	green	SSWTLRGI	SSWTLRGII	SSWTLRGOI
black	yellow	SSWTLRYI	SSWTLRYII	SSWTLRYOI
black	blue	SSWTLRBI	SSWTLRBII	SSWTLRBOI
stainless steel, polished	white	SVATLRWI	SVATLRWII	SVATLRWOI
stainless steel, polished	red	SVATLRRI	SVATLRRII	SVATLRROI
stainless steel, polished	green	SVATLRGI	SVATLRGII	SVATLRGOI
stainless steel, polished	yellow	SVATLRYI	SVATLRYII	SVATLRYOI
stainless steel, polished	blue	SVATLRBI	SVATLRBII	SVATLRBOI

About Us

→ Pushbuttons and Switches

Panel Mount Jacks

Emergency-Stop Buttons

Bus Technology

RFID

Enclosures

Pedal Switches

Terminal Blocks

Type Index

Pushbuttons

Illustration

Dimensions

IP65
IP67

2,3mm

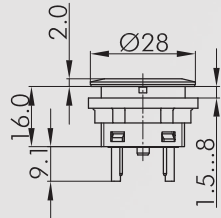

Pushbutton with ring illumination and inscription

incl. lens and white LED
standard imprints see nameplates from page 634 (please specify index no.)
special inscription on request
Faston terminals 2.8x0.8 mm

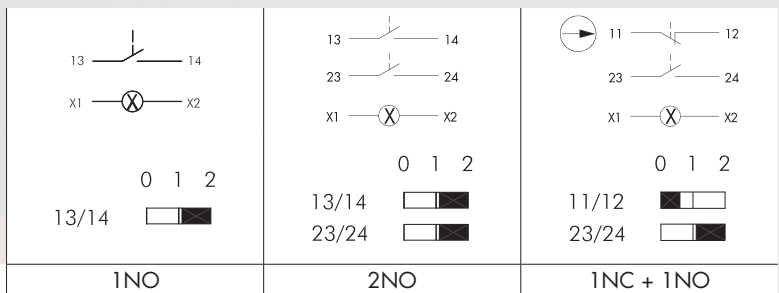

front bezel	illuminated ring	1NO	2NO	1NC + 1NO
silver-coloured	white	STLRWI...	STLRWII...	STLRWOI...
silver-coloured	red	STLRRI...	STLRRII...	STLRROI...
silver-coloured	green	STLRGI...	STLRGII...	STLRGOI...
silver-coloured	yellow	STLRYI...	STLRYII...	STLRYOI...
silver-coloured	blue	STLRBI...	STLRBII...	STLRBOI...
stainless steel, polished	white	SVATLRWI...	SVATLRWII...	SVATLRWOI...
stainless steel, polished	red	SVATLRRI...	SVATLRRII...	SVATLRROI...
stainless steel, polished	green	SVATLRGI...	SVATLRGII...	SVATLRGOI...
stainless steel, polished	yellow	SVATLRYI...	SVATLRYII...	SVATLRYOI...
stainless steel, polished	blue	SVATLRBI...	SVATLRBII...	SVATLRBOI...

Pushbuttons

Illustration

Dimensions

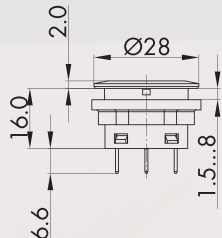

Tactile pushbutton with ring illumination

incl. white LED
with gold-plated contacts
Faston terminals 2.8x0.8 mm

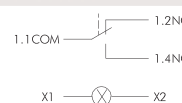

front bezel		illuminated ring		1 inverter
silver-coloured		white		SCTLRWF
silver-coloured		red		SCTLRRF
silver-coloured		green		SCTLRGF
silver-coloured		yellow		SCTLRYF
silver-coloured		blue		SCTLRBF
black		white		SSWCTLRWF
black		red		SSWCTLRRF
black		green		SSWCTLRGF
black		yellow		SSWCTLRYF
black		blue		SSWCTLRBF
stainless steel, polished		white		SVACTLRWF
stainless steel, polished		red		SVACTLRRF
stainless steel, polished		green		SVACTLRGF
stainless steel, polished		yellow		SVACTLRYF
stainless steel, polished		blue		SVACTLRBF

About Us

→ Pushbuttons and Switches

Panel Mount Jacks

Emergency-Stop Buttons

Bus Technology

RFID

Enclosures

Pedal Switches

Terminal Blocks

Type Index

Pushbuttons

Illustration

Dimensions

IP65
IP67

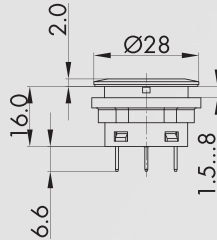

Illuminated tactile pushbutton with ring illumination and laser printing

incl. lens and white LED

standard imprints see nameplates from page 634 (please specify index no.)

special inscription on request

Faston terminals 2.8x0.8 mm

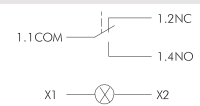

front bezel	illuminated ring	1 inverter
silver-coloured	white	SCTLRWF...
silver-coloured	red	SCTLRRF...
silver-coloured	green	SCTLRGF...
silver-coloured	yellow	SCTLRYF...
silver-coloured	blue	SCTLRBF...
stainless steel, polished	white	SVACTLRWF...
stainless steel, polished	red	SVACTLRRF...
stainless steel, polished	green	SVACTLRGF...
stainless steel, polished	yellow	SVACTLRYF...
stainless steel, polished	blue	SVACTLRBF...

Membrane Pushbuttons

Illustration

Dimensions

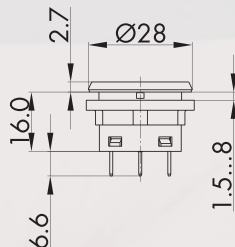

Illuminated tactile membrane pushbutton made of stainless steel V4A

combining the advantages of a membrane keypad with the flexibility of conventional actuators, with blank nameplate standard inscription (see from page 634) or special imprints on request incl. white LED with gold-plated contacts Faston terminals 2.8x0.8 mm

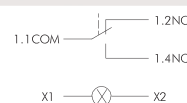

front bezel		front ring		1 inverter
black		black		SSWCFTLF
stainless steel, polished		black		SVACFTLF

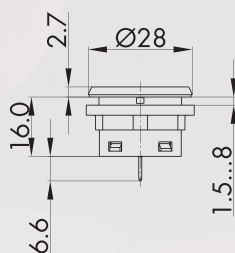

Tactile membrane pushbutton made of stainless steel V4A

combining the advantages of a membrane keypad with the flexibility of conventional actuators, with blank nameplate standard inscription (see from page 634) or special imprints on request with gold-plated contacts Faston terminals 2.8x0.8 mm



front bezel		front ring		1 inverter
black		black		SSWCFTF
stainless steel, polished		black		SVACFTF

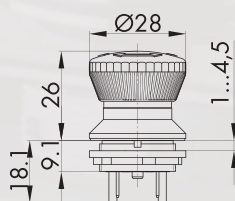

Emergency-stop 2NC+1NO

Foolproof: yes
Switching position indicator: yes

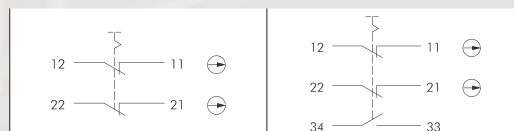

front bezel		mushroom head		2NC	2NC + 1NO
yellow		red		FRVKOO	FRVKOOI

Emergency-Stops

Illustration

Dimensions

IP65
IP67

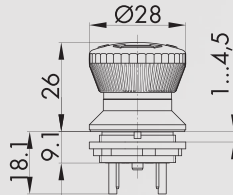

Illuminated emergency-stop

Foolproof: yes

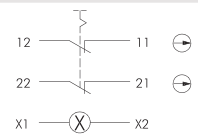

front bezel	mushroom head	2NC
yellow	red	FRVKLOO

IP65
IP67

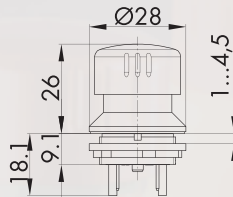

Emergency-stop made of aluminium for robust applications

Foolproof: yes

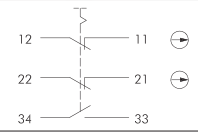

front bezel	mushroom head	2NC + 1NO
yellow	red	FRVKALOOI

IP65
IP67

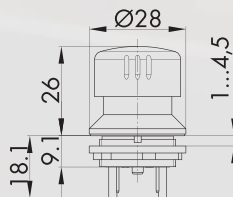

Emergency-stop made of aluminium for robust applications

Foolproof: yes

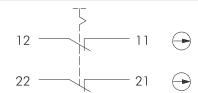

front bezel	mushroom head	2NC
yellow	red	FRVKALOO

Emergency-Stops

Abbildung

Abmessungen

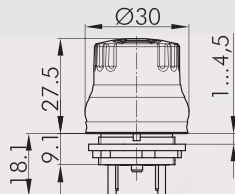

Emergency-stop for hygienic applications 2NC+1O

hygienic test acc. to DIN EN 1672-2 / DIN EN ISO 14159 and GS-NV 6

Foolproof: yes
Switching position indicator: no

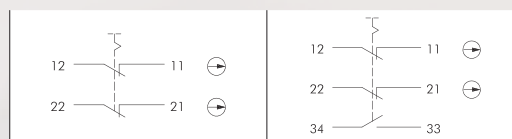

front bezel	mushroom head	2NC	2NC + 1NO
yellow	red	FRVKPOO	FRVKPOOL

IP65
IP67

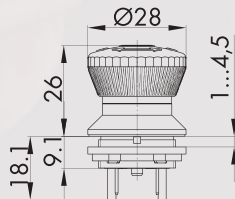

Not-Halt-Taster mit Zug- und Drehentriegelung

Foolproof: yes

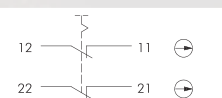

front bezel	mushroom head	2O
yellow	red	FRZVKOO

IP65
IP67

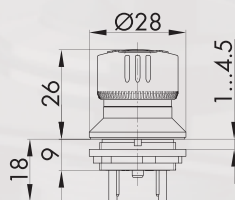

Active illuminated safety emergency-stop with position indication active/inactive

delivery without diagnostic unit for LED monitoring
LED: 24V DC/18mA

Foolproof: yes

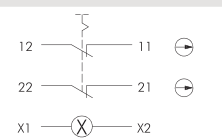

front bezel	Mushroom head	2NC
yellow	red/grey	FRVKDOO

Accessories for Pushbuttons and Switches

Illustration

Dimensions

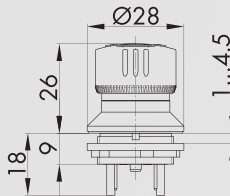

Active illuminated emergency-stop with status indication active (illuminated) / inactive (non-illuminated)

- red illuminated emergency-stop (active) acc. to EN ISO 13850:2015
- LED with 0-ohm resistor
- delivery without external LED monitoring
- less mounting depth
- 2 NC

Possible applications, e.g.:

- pluggable or wireless operator stations
- pluggable system components which are stationary available but only temporarily in operation

Foolproof: yes

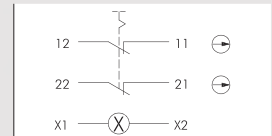

front bezel	Mushroom head	2NC
yellow	red/grey	FRVKDOO_R0

Accessories

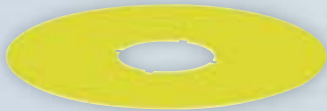

Yellow nameplate

self-adhesive PVC foil
printing on request
outer dia. 75 mm
for mounting dia. 22.3 mm

colour: yellow NAS_22

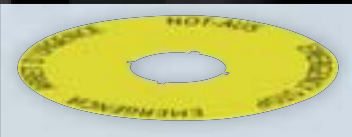

Yellow nameplate with quadrilingual imprint

self-adhesive PVC foil
outer dia. 75 mm
for mounting dia. 22.3 mm

colour: yellow NAS_22_548

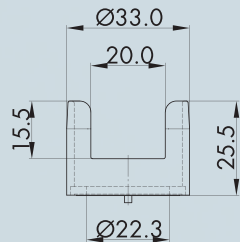

Protective shroud



colour: yellow RRSK

Potentiometers

Illustration

Dimensions



Insulating case

for Faston clamp FH2,8, slip on from the front

IH2,8



Faston clamp 2.8 x 0.8 mm with snap-in pin

cross section 0.75 - 1.50 mm², tin-plated brass, with pin to snapfit into the sockets XA, XAL and the insulating case IH2.8

FH2,8

IP66
IP69K

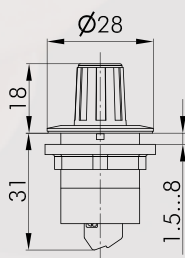

Potentiometer 1 kOhm

- with 1 kOhm potentiometer
- rotation angle 260°
- with integrated scale
- 100.000 cycles
- operating temperature -20°C ... 70°C
- screw connection

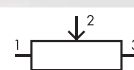

front bezel		
silver-coloured		SR1K
black		SSWR1K
stainless steel, polished		SVAR1K

IP66
IP69K

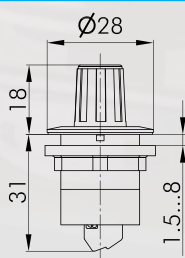

Potentiometer 5 kOhm

- with 5 kOhm potentiometer
- rotation angle 260°
- with integrated scale
- 100.000 cycles
- operating temperature -20°C ... 70°C
- screw connection

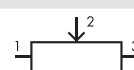

front bezel		
silver-coloured		SR5K
black		SSWR5K
stainless steel, polished		SVAR5K

About Us

→ Pushbuttons and Switches

Panel Mount Jacks

Emergency-Stop Buttons

Bus Technology

RFID

Enclosures

Pedal Switches

Terminal Blocks

Type Index

Potentiometers

Illustration

Dimensions

IP66
IP69K

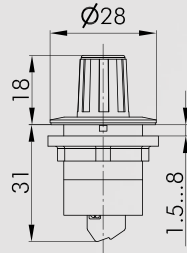

Potentiometer 10 kOhm

- with 10 kOhm potentiometer
 - rotation angle 260°
 - with integrated scale
 - 100.000 cycles
 - operating temperature -20°C ... 70°C
- screw connection

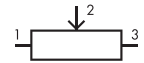

front bezel		
silver-coloured		SR10K
black		SSWR10K
stainless steel, polished		SVAR10K

IP66
IP69K

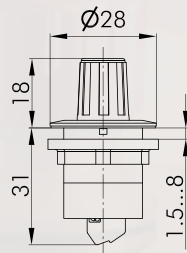

Potentiometer 50 kOhm

- with 50 kOhm potentiometer
 - rotation angle 260°
 - with integrated scale
 - 100.000 cycles
 - operating temperature -20°C ... 70°C
- screw connection

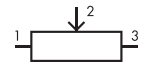

front bezel		
silver-coloured		SR50K
black		SSWR50K
stainless steel, polished		SVAR50K

Selector Switches (momentary/maintained)

I = Switching position
> = Spring return

Illustration

Dimensions

IP65

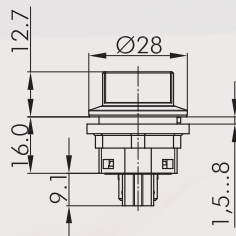

Selector switch, maintained

Faston terminals 2.8x0.8 mm



2NO	1NC + 1NO
front bezel	
silver-coloured	SWBII
black	SSWWBII
stainless steel, polished	SVAWBII



1NO	2NO	1NC + 1NO
front bezel		
silver-coloured	SWAI	SWAOI
black	SSWWAI	SSWWAOI
stainless steel, polished	SVAWAI	SVAWAOI

About Us

→ Pushbuttons and Switches

Panel Mount Jacks

Emergency/Stop Buttons

Bus Technology

RFID

Enclosures

Pedal Switches

Terminal Blocks

Type Index

Selector Switches (momentary/maintained)

| = Switching position
> = Spring return

Illustration

Dimensions

IP65

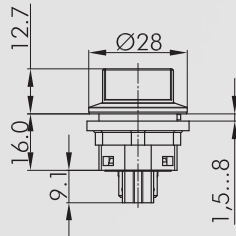

Selector switch, momentary

Faston terminals 2.8x0.8 mm



front bezel		2NO	1NC + 1NO
silver-coloured		SSTBII	SSTBOI
black		SSWSTBII	SSWSTBOI
stainless steel, polished		SVASTBII	SVASTBOI

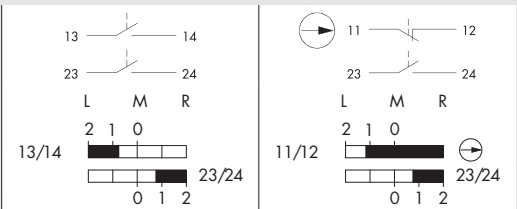

front bezel		1NO	2NO	1NC + 1NO
silver-coloured		SSTAI	SSTAI	SSTAOI
black		SSWSTAI	SSWSTAI	SSWSTAOI
stainless steel, polished		SVASTAI	SVASTAI	SVASTAOI

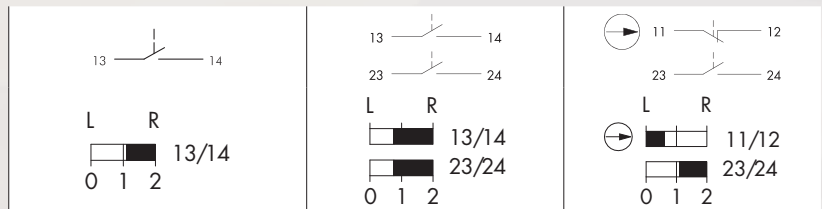

IP65

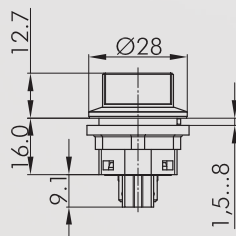

Selector switch, left maintained, right momentary

Faston terminals 2.8x0.8 mm

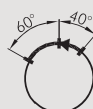

front bezel		2NO	1NC + 1NO
silver-coloured		SWCII	SWCOI
black		SSWWCII	SSWWCOI
stainless steel, polished		SVAWCII	SVAWCOI

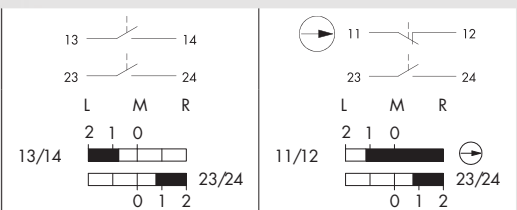

Selector Switches (momentary/maintained)

I = Switching position
> = Spring return

Illustration

Dimensions

IP65

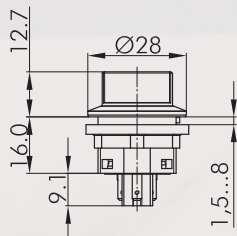

Illuminated selector switch, maintained

Faston terminals 2.8x0.8 mm

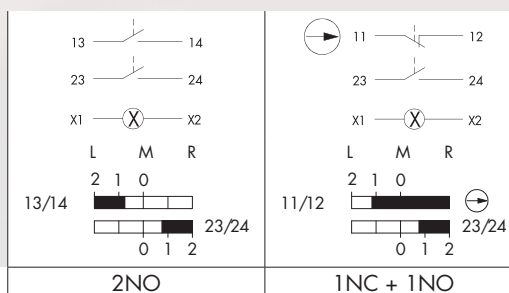
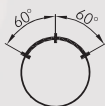

<i>front bezel</i>		2NO	1NC + 1NO
silver-coloured		SWBLII	SWBLOI
black		SSWWBLII	SSWWBLOI
stainless steel, polished		SVAWBLII	SVAWBLOI

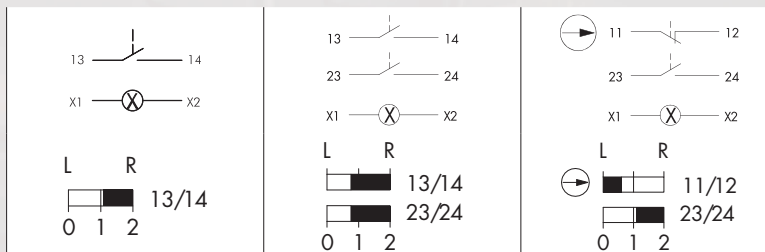

<i>front bezel</i>		1NO	2NO	1NC + 1NO
silver-coloured		SWALI	SWALII	SWALOI
black		SSWWALI	SSWWALII	SSWWALOI
stainless steel, polished		SVAWALI	SVAWALII	SVAWALOI

About Us

→ Pushbuttons and Switches

Panel Mount Jacks

Emergency-Stop Buttons

Bus Technology

RFID

Enclosures

Pedal Switches

Terminal Blocks

Type Index

Selector Switches (momentary/maintained)

I = Switching position
> = Spring return

Illustration

Dimensions

IP65

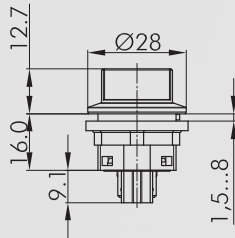

Illuminated selector switch, momentary

Faston terminals 2.8x0.8 mm



front bezel		2NO	1NC + 1NO
silver-coloured		SSTBLII	SSTBLOI
black		SSWSTBLII	SSWSTBLOI
stainless steel, polished		SVASTBLII	SVASTBLOI

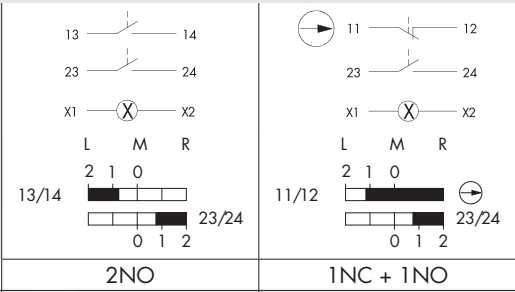

front bezel	1NO	2NO	1NC + 1NO
silver-coloured		SSTALI	SSTALOI
schwarz		SSWSTALI	SSWSTALOI
stainless steel, polished		SVASTALI	SVASTALOI

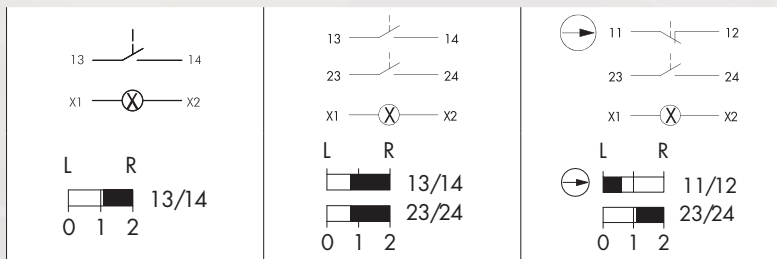

Selector Switches (momentary/maintained)

l = Switching position
> = Spring return

Illustration

Dimensions

IP65

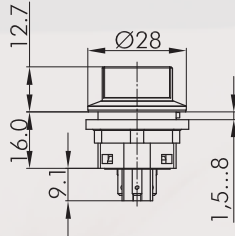

Illuminated selector switch, left maintained, right momentary

Faston terminals 2.8x0.8 mm

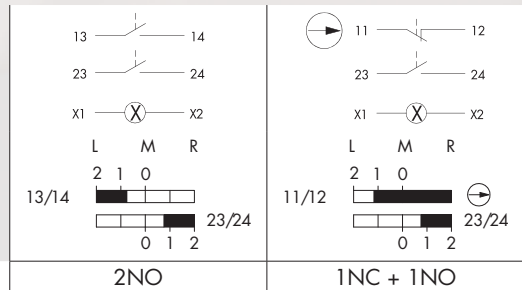

<i>front bezel</i>			
silver-coloured		SWCLII	SWCLOI
black		SSWWCLII	SSWWCLOI
stainless steel, polished		SVAWCLII	SVAWCLOI

About Us

→ Pushbuttons and Switches

Panel Mount Jacks

Emergency-Stop Buttons

Bus Technology

RFID

Enclosures

Pedal Switches

Terminal Blocks

Type Index

Key Switches (momentary/maintained)

I = Switching position
> = Spring return
O = Key removable position

Illustration

Dimensions

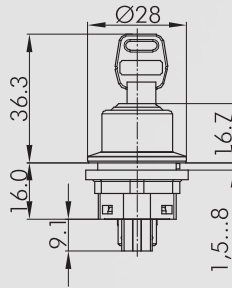

IP65



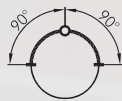
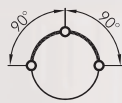

Key-operated switch, maintained

including two keys
other lock types on request
Faston terminals 2.8x0.8 mm



front bezel	2NO	1NC + 1NO
silver-coloured 	SSSA12II	SSSA12OI
black 	SSWSSA12II	SSWSSA12OI
stainless steel, polished 	SVASSA12II	SVASSA12OI

front bezel	2NO	1NC + 1NO
silver-coloured 	SSSA13II	SSSA13OI
black 	SSWSSA13II	SSWSSA13OI
stainless steel, polished 	SVASSA13II	SVASSA13OI

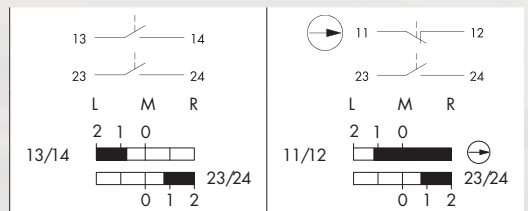
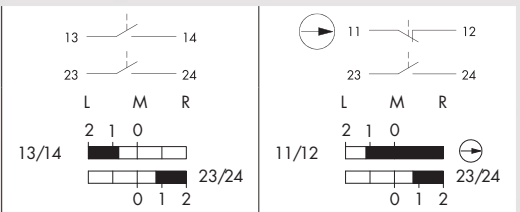

Key Switches (momentary/maintained)

I = Switching position
> = Spring return
O = Key removable position

Illustration

Dimensions

IP65

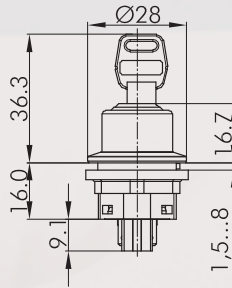

Key-operated switch, maintained (3 different keys)

including three keys
1st key: two-way operation
2nd key: operation only to the left
3rd key: operation only to the right
Faston terminals 2.8x0.8 mm

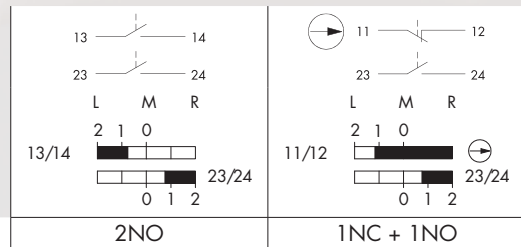
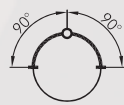

front bezel		2NO	1NC + 1NO
silver-coloured		SSSA31II	SSSA31OI
black		SSWSSA31II	SSWSSA31OI
stainless steel, polished		SVASSA31II	SVASSA31OI

About Us

→ Pushbuttons and Switches

Panel Mount Jacks

Emergency-Stop Buttons

Bus Technology

RFID

Enclosures

Pedal Switches

Terminal Blocks

Type Index

Key Switches (momentary/maintained)

I = Switching position
> = Spring return
O = Key removable position

Illustration

Dimensions

IP65

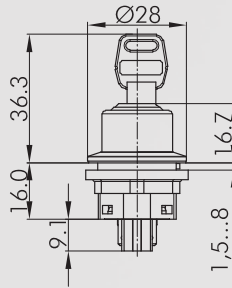

Key-operated switch, maintained

including two keys
other lock types on request
Faston terminals 2.8x0.8 mm

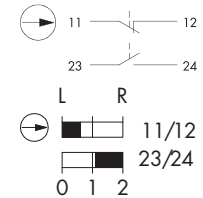
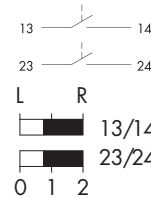
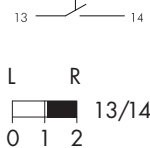

<i>front bezel</i>		1NO	2NO	1NC + 1NO
silver-coloured		SSSA14I	SSSA14II	SSSA14OI
black		SSWSSA14I	SSWSSA14II	SSWSSA14OI
stainless steel, polished		SVASSA14I	SVASSA14II	SVASSA14OI



<i>front bezel</i>		1NO	2NO	1NC + 1NO
silver-coloured		SSSA15I	SSSA15II	SSSA15OI
black		SSWSSA15I	SSWSSA15II	SSWSSA15OI
stainless steel, polished		SVASSA15I	SVASSA15II	SVASSA15OI



<i>front bezel</i>		1NO	2NO	1NC + 1NO
silver-coloured		SSSA16I	SSSA16II	SSSA16OI
schwarz		SSWSSA16I	SSWSSA16II	SSWSSA16OI
stainless steel, polished		SVASSA16I	SVASSA16II	SVASSA16OI



<i>front bezel</i>		1NO	2NO	1NC + 1NO
silver-coloured		SSSA17I	SSSA17II	SSSA17OI
black		SSWSSA17I	SSWSSA17II	SSWSSA17OI
stainless steel, polished		SVASSA17I	SVASSA17II	SVASSA17OI



<i>front bezel</i>		1NO	2NO	1NC + 1NO
silver-coloured		SSSA18I	SSSA18II	SSSA18OI
black		SSWSSA18I	SSWSSA18II	SSWSSA18OI
stainless steel, polished		SVASSA18I	SVASSA18II	SVASSA18OI



Accessories



Spare keys
please specify key number

ESMIC...

Buzzers/Pilot Lights

Illustration

Dimensions

IP65

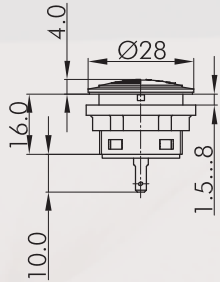

Buzzer

operating voltage: 24V DC
operating current: 10mA
signal frequency: 4.1 +/- 0.5 kHz
volume: max. 83 db (10cm)
operating temperature: -20°C ... 70°C
Faston terminals 2.8x0.8 mm

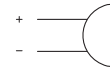

front bezel		
silver-coloured		SNSG+SG-24V
black		SSWNSG+SG-24V
stainless steel, polished		SVANSG+SG-24V

IP65

IP67

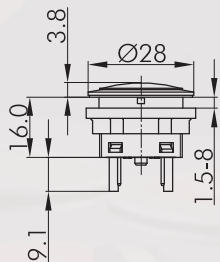

Pilot light

incl. white LED
Faston terminals 2.8 mm



front bezel		
silver-coloured		SNL
black		SSWNL
stainless steel, polished		SVANL

Accessories



Lens

colour:	blue		K22RRBL
	yellow		K22RRGB
	green		K22RRGN
	clear		K22RRKL
	red		K22RRRT
	opal white		K22RRWS

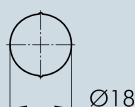

Blank nameplate

BSRRU

Accessories for Contact Blocks

Illustration

Dimensions

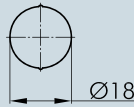

Nameplate with standard imprint

please specify index number (see nameplates from page 634)

BSRR...

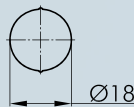

Nameplate with special imprint

according to customer's specification

BSRRB



Faston clamp 2.8 x 0.8 mm with snap-in pin

cross section 0.75 - 1.50 mm², tin-plated brass, with pin to snapfit into the sockets XA, XAL and the insulating case IH2.8

FH2,8



Insulating case

for Faston clamp FH2,8, slip on from the front

IH2,8



Spacer ring

suitable for the Shortron series
for panel thickness from 0.5 to 2.5 mm

colour: silver-coloured
black



SDR
SDRSW



Mounting tool 22

with torque limitation
for the series QUARTEX-R(-JUWEL), KOMBITAST-R-JUWEL, RONDEX, RONDEX-M, RONDEX-JUWEL, RVA, DUX-Basic, SHORTRON, jacks of the ranges RONTRON-R/-QJUWEL

S22



Mounting tool adapter with 1/4" connections

for mounting tools S16 and S22

SRA

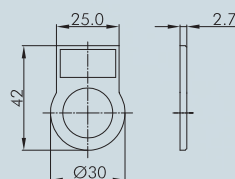

External nameplate holder

for self-adhesive outside marking of the actuators of the RONTRON-RJUWEL, SHORTRON series (except selector and key switches) to snap on from the front

colour: transparent



RRJABT

Self-adhesive nameplate laser-printed

inscription according to customer's specification
dimensions: 22 x 11 mm

BZ16L...

Accessories for Contact Blocks

Illustration

Dimensions



Self-adhesive nameplate blank

BZ16U

dimensions: 22 x 11 mm



Self-adhesive nameplate with standard imprint

BZ16B...

please specify index number(see nameplates from page 634)
dimensions: 22 x 11 mm

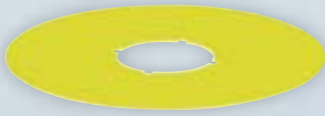

Yellow nameplate

self-adhesive PVC foil
printing on request
outer dia. 75 mm
for mounting dia. 22.3 mm

colour: yellow



NAS_22



Yellow nameplate with quadrilingual imprint

self-adhesive PVC foil
outer dia. 75 mm
for mounting dia. 22.3 mm

colour: yellow



NAS_22_548



Universal lens remover

USK

IP40



Lead-sealable protective lid

colour: transparent



KDP22RR

IP65
IP67



Lead-sealable, robust, tight protective lid

colour: transparent
black



**KDPR22RR
KDPR22RR_SW**

IP67



Protective lid made of TPE

colour: black



AK22RRSW