



→ Rontron-R-Juwel jacks

- USB	page	575
- Fire wire	page	580
- RJ45	page	580
- PS2	page	581
- SVHS	page	581
- HDMI	page	582
- M12	page	582
- Optical fibre	page	582
- Plug jack	page	582
- Accessories	page	584

→ Rontron-Q-Juwel jacks

- USB	page	587
- Fire wire	page	588
- RJ45	page	588
- Accessories	page	589

→ Oktron-Juwel jacks

- USB	page	591
-------	------	-----

→ Quartron-Juwel jacks

- VGA	page	593
- RS232	page	593

RONTRON-R-JUWEL

Ø 22.3 mm

MADE IN GERMANY

SCHLEGEL[®]
ELEKTROKONTAKT

Cutout dimensions

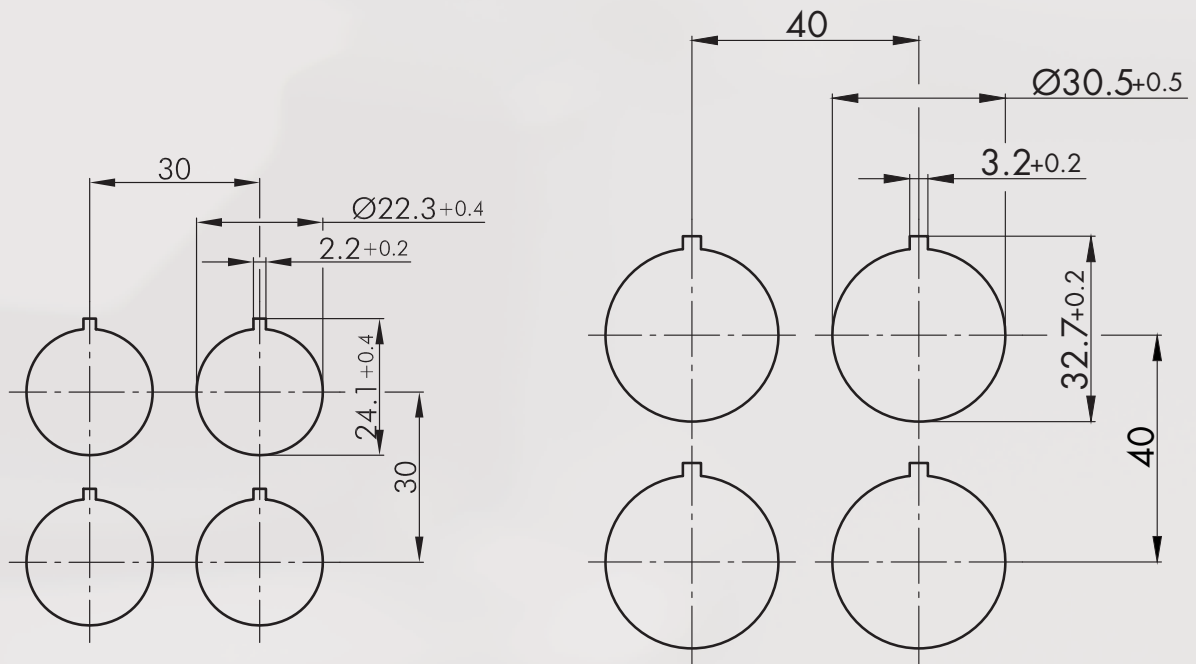

About Us

Pushbuttons/Switches

← Panel Mount locks

Emergency-Stop Buttons

Bus Technology

RFID

Enclosures

Pedal Switches

Terminal Blocks

Type Index

Panel Mount Jacks

other cable lengths on request

Illustration

Dimensions

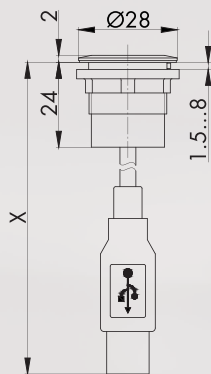

Description

Type



USB2.0 jack A/connector A (60 cm)

front:
USB2.0 jack type A
rear:
USB2.0 cable (length X=600 mm) with plug type A
Attention: Mounting position of the USB jack does not comply with the USB2.0 specification

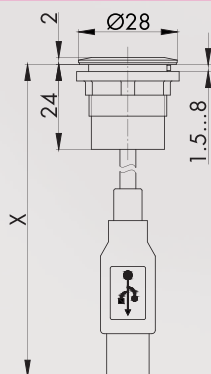

front bezel: silver-coloured 
 stainless steel, polished 
 black 

RRJ_USB
RRJVA_USB
RRJ_USB_SW



USB2.0 jack A/connector A (150 cm)

front:
USB2.0 jack type A
rear:
USB2.0 cable (length X = 1500 mm) with plug type A
Attention: Mounting position of the USB jack does not comply with the USB2.0 specification

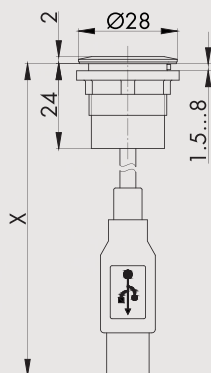

front bezel: silver-coloured 
 stainless steel, polished 
 black 

RRJ_USB_150CM
RRJVA_USB_150CM
RRJ_USB_SW_150CM



USB3.0 jack A/connector A (60 cm)

front:
USB3.0 jack type A
rear:
USB3.0 cable (length X=600 mm) with plug type A

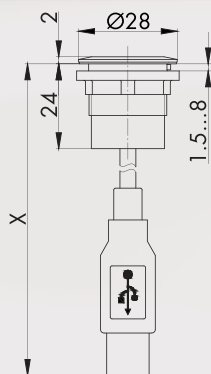

front bezel: silver-coloured 
 stainless steel, polished 
 black 

RRJ_USB3
RRJVA_USB3
RRJ_USB3_SW



USB3.0 jack A/connector A (150 cm)

front:
USB3.0 jack type A
rear:
USB3.0 cable (length X= 1500 mm) with plug type A

front bezel: silver-coloured 
 black 

RRJ_USB3_150CM
RRJ_USB3_SW_150

Panel Mount Jacks

other cable lengths on request

Illustration

Dimensions

Description

Type

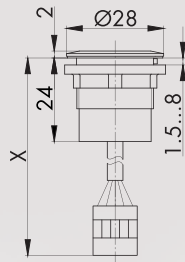

USB2.0 jack A/connector socket housing (100 cm)

front:
USB2.0 jack type A
rear:
USB2.0 cable (length X = 1000 mm) with 5-pole socket housing
(grid dimension 2.54 mm)
for direct connection to a motherboard

front bezel: silver-coloured



RRJ_USB100CM_673

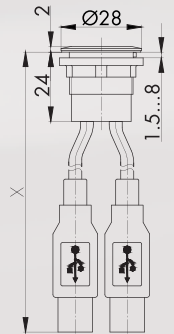

Double USB2.0 jack A/connector A (60 cm)

front:
2x USB2.0 jack type A
rear:
2x USB2.0 cable (length X=600 mm) with plug type A

front bezel: silver-coloured
stainless steel, polished
black



RRJ_2USB
RRJVA_2USB
RRJ_2USB_SW

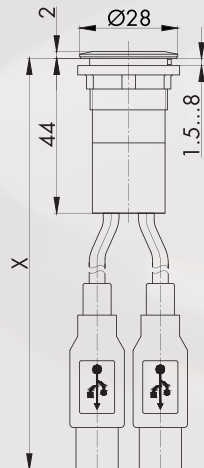

Double USB3.0 jack A/connector A (60 cm)

front:
2x USB3.0 - jack type A
rear:
2x USB3.0 cable (length X=600 mm) with plug type A

front bezel: silver-coloured
black



RRJ_2USB3
RRJ_2USB3_SW

Panel Mount Jacks

Illustration

Dimensions

Description

Type

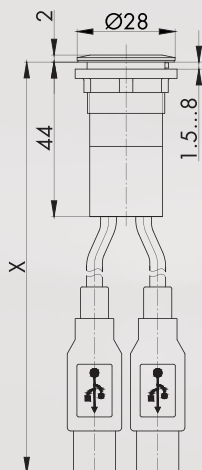

Double USB3.0 jack A/connector A (150 cm)

front:
2x USB3.0 - jack type A
rear:
2x USB3.0 cable (length X=1500 mm) with plug type A

front bezel: silver-coloured
black



RRJ_USB3_150CM
RRJ_USB3_SW_150

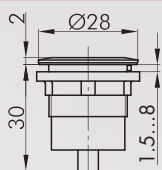

USB2.0 jack A/jack A

front:
USB2.0 jack type A
rear:
USB2.0 jack type A

front bezel: silver-coloured
stainless steel, polished
black



RRJ_USB_AA
RRJVA_USB_AA
RRJ_USB_SW_AA

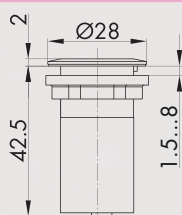

Illuminated USB2.0 jack A/jack A

with illuminated USB symbol
front:
USB2.0 jack type A
rear:
USB2.0 jack type A

front bezel: silver-coloured



RRJ_USB_AA_B

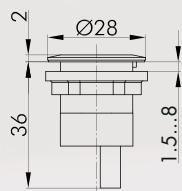

USB3.0 jack A/jack A

pinout 1:1
front:
USB3.0 jack type A
rear:
USB3.0 jack type A

front bezel: silver-coloured
stainless steel, polished
black



RRJ_USB3_AA
RRJVA_USB3_AA
RRJ_USB3_SW_AA

About Us

Pushbuttons/Switches

Panel Mount Jacks

Emergency/Stop Buttons

Bus Technology

RFID

Enclosures

Pedal Switches

Terminal Blocks

Type Index

RONTRON-R-JUWEL











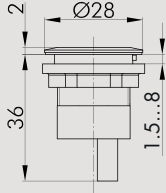



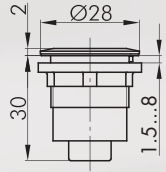

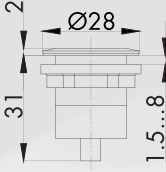

Ø 22.3 mm

MADE IN GERMANY

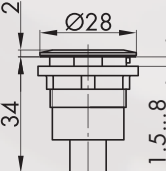

Panel Mount Jacks

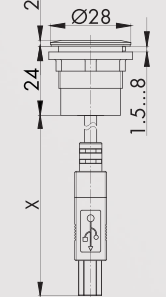
- About Us
- Pushbuttons/Switches
- Panel Mount Jacks
- Emergency-Stop Buttons
- Bus Technology
- RFD
- Enclosures
- Pedal Switches
- Terminal Blocks
- Type Index

Illustration	Dimensions	Description	Type	
		USB3.0 jack A/jack A (twisted data line) pinout: twisted data line front: USB3.0 jack type A rear: USB3.0 jack type A	front bezel: silver-coloured  stainless steel, polished 	RRJ_USB3_AA_633 RRJVA_USB3_AA633
		USB2.0 jack A/jack B front: USB2.0 jack type A rear: USB2.0 jack type B	front bezel: silver-coloured  stainless steel, polished  black 	RRJ_USB_AB RRJVA_USB_AB RRJ_USB_SW_AB
		USB2.0 jack B/jack A front: USB2.0 jack type B rear: USB2.0 jack type A	front bezel: silver-coloured  stainless steel, polished  black 	RRJ_USB_BA RRJVA_USB_BA RRJ_USB_SW_BA
		USB2.0 jack B/jack B front: USB2.0 jack type B rear: USB2.0 jack type B	front bezel: silver-coloured  stainless steel, polished  black 	RRJ_USB_BB RRJVA_USB_BB RRJ_USB_SW_BB
		USB2.0 jack B/connector B (50 cm) front: USB2.0 jack type B rear: USB2.0 cable (length X = 500 mm) with plug type B	front bezel: silver-coloured 	RRJ_USB_BB_50CM

Panel Mount Jacks

Illustration

Dimensions

Description

Type

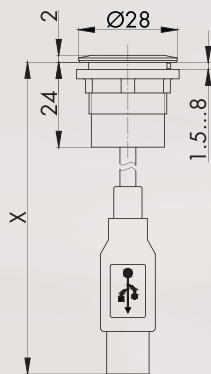

Mini USB2.0 jack B/connector A (60 cm)

front:
mini USB2.0 jack type B
rear:
USB2.0 cable (length X=600 mm) with plug type A

front bezel: silver-coloured



RRJ_MINI_USB

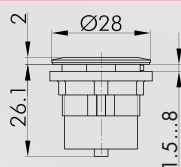

Mini USB2.0 jack B/jack B

front:
mini USB2.0 jack type B
rear:
mini USB2.0 jack type B

front bezel: silver-coloured
black



RRJ_MINIUSB_BB
RRJ_MINIUSBSW_BB

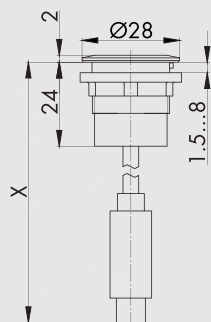

USB2.0 jack C/connector C (60 cm)

front:
USB2.0 jack type C
rear:
USB2.0 cable (length X=600 mm) with plug type C

front bezel: silver-coloured



RRJ_USB_CC_60

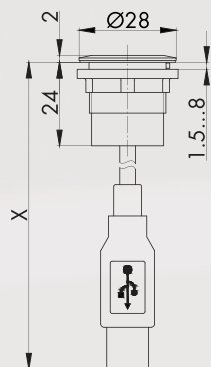

USB2.0 jack C/connector A (60 cm)

front:
USB2.0 jack type C
rear:
USB2.0 cable (length X=600 mm) with plug type A

front bezel: silver-coloured



RRJ_USB_CA_60

Panel Mount Jacks

other cable lengths on request

Abbildung Abmessungen Beschreibung Type

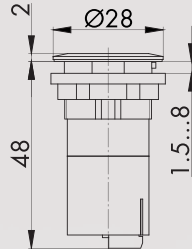

USB charging jack

for charging USB devices in industrial sectors and in public transport

input voltage: 12 and 24 V DC

output voltage: 4.75 - 5.25 V DC output current: 1.5A

colour: silver-coloured black



RRJ_USB_A_5V
RRJ_USB_SW_A_5V



Connector for USB charging jacks

SV_FKC2,5

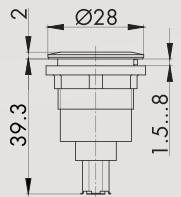

Fire wire jack/jack

front: Fire Wire jack

rear: Fire Wire jack

front bezel: silver-coloured stainless steel, polished



RRJ_FW6_STB
RRJVA_FW6_STB

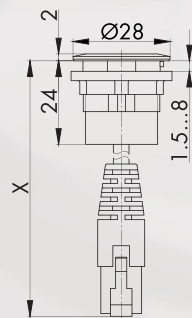

RJ45 jack/connector (60 cm)

front: RJ45 jack with screen

rear: cable (length X=600 mm) with RJ45 plug with screen

front bezel: silver-coloured stainless steel, polished black



RRJ_RJ45
RRJVA_RJ45
RRJ_RJ45_SW

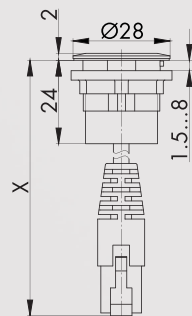

RJ45 jack/connector (150 cm)

front: RJ45 jack with screen

rear: cable (length X=1500 mm) with RJ45 plug with screen

front bezel: silver-coloured black



RRJ_RJ45_150CM
RRJ_RJ45SW_150CM

Panel Mount Jacks

other cable lengths on request

Abbildung

Abmessungen

Beschreibung

Type

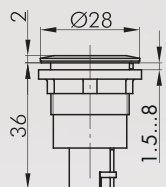

RJ45 jack/jack

front:
RJ45 jack with screen
rear:
RJ45 jack with screen

front bezel: silver-coloured
stainless steel, polished
black



RRJ_RJ45_STB
RRJVA_RJ45_STB
RRJ_RJ45_STB_SW

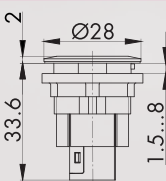

RJ45 jack/jack CAT6

front:
RJ45 jack with screen
rear:
RJ45 jack with screen

front bezel: silver-coloured



RRJ_RJ45_STBCAT6

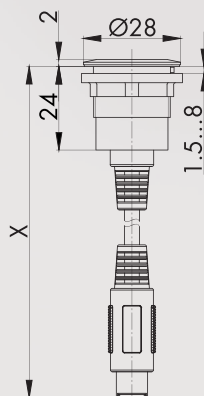

PS2 jack/connector (200 cm)

front:
PS2 jack
rear:
cable (length X=2000 mm) with PS2 plug

front bezel: silver-coloured



RRJ_PS2_200CM

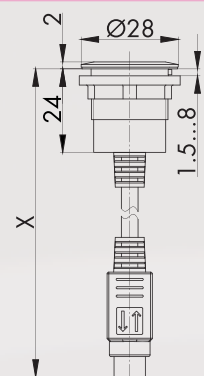

SVHS jack/connector (200 cm)

front:
SVHS jack
rear:
cable (length X=2000 mm) with SVHS plug

front bezel: silver-coloured



RRJ_SVHS_200CM

Panel Mount Jacks

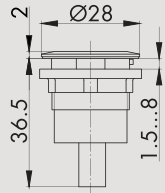

other cable lengths on request

Abbildung Abmessungen Beschreibung Type



HDMI jack/jack

front:
HDMI jack
rear:
HDMI jack

front bezel: silver-coloured 
 stainless steel, polished 
 black 

RRJ_HDMI_STB
RRJVA_HDMI_STB
RRJ_HDMI_STB_SW

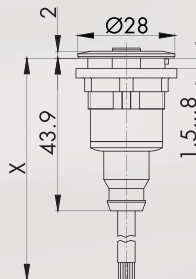

M12 jack/jack 4-pole

front:
M12 jack: 4-pole, A-coded
rear:
open cable end (length X=1000 mm)

front bezel: silver-coloured 

RRJ_M124A_100CM

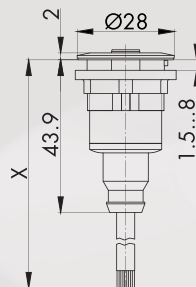

M12 jack/jack 5-pole

front:
M12 jack: 5-pole, A-coded
rear:
open cable end (length X=1000 mm)

front bezel: silver-coloured 

RRJ_M125A_100CM

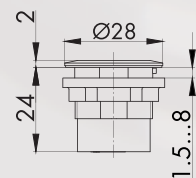

Optical fibres LC jack/LC jack

- LC/LC coupling
- fiber type OM2

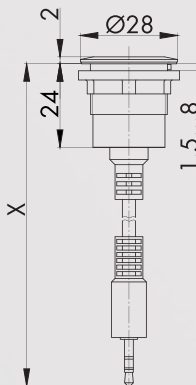

front bezel: silver-coloured 

RRJ_LWL_LC_OM2



2.5 mm plug jack/connector (200 cm)

front:
2.5 mm jack socket (3-pole)
rear:
cable (length X=2000 mm) with 2.5 mm jack plug

front bezel: silver-coloured 
 stainless steel, polished 

RRJ_KL2,5_200CM
RRJVA_KL2,5_200

Panel Mount Jacks

other cable lengths on request

Illustration

Dimensions

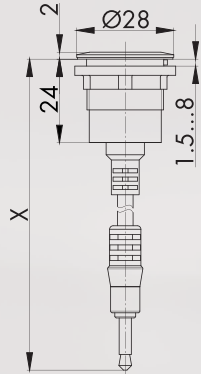

Description

Type



3.5 mm plug jack/connector

front:
3.5 mm jack socket (3-pole)
rear:
cable (length X=2000 mm) with 3.5 mm jack plug

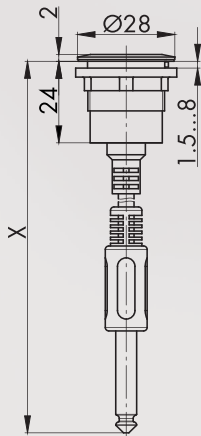

front bezel: silver-coloured 
 stainless steel, polished 

RRJ_KL3,5_200CM
RRJVA_KL3,5_200



6.3 mm plug jack/connector (200 cm)

front:
6.3 mm jack socket (3-pole)
rear:
cable (length X=2000 mm) with 6.3 mm jack plug

front bezel: silver-coloured 
 acier inox poli 

RRJ_KL6,3_200CM
RRJVA_KL6,3_200



Adapter for panel mount jacks

allows true-to-size mounting of all flush-mounted jacks of the Rontron-R-Juwel series into cut-outs of 30.5 mm dia., the jack is not included in delivery

colour: silver-coloured 

KRJM22R

Accessories RONTRON-R-JUWEL

Ø 22,3 mm

MADE IN GERMANY



Accessories for Panel Mount Jacks

Abbildung Abmessungen Beschreibung Type



Accessories

IP69K



Robust tight protection cap

- captive lid, threadable
- suitable for the series Rontron-R-Juwel, Rondex-Juwel and Shortron

colour: aluminum  **SDAL22RR**
 stainless steel, polished  **SDVA22RR**

IP40



Lead-sealable Protective Lid

from -30 °C to +70°C



colour: transparent  **KDP22RR**

IP65
IP67



Lead-sealable, robust Protective Lid

Lifetime: >100,000 cycles

colour: transparent 
 black  **KDPR22RR**
 KDPR22RR_SW

IP67



Protective Lid made of TPE

from -50 °C to +100°C

colour: black  **AK22RRSW**



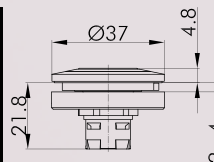

Fixing nut for an extended clamping range up to 11 mm M22F

IP65









LED Light Ring for status indication or additional illumination

- for an additional light signal
- rated voltage: 24V AC/DC
- rated current: 25 ... 35 mA (DC)
- 30.5 mm mounting aperture
- Connection: for JST plug ZHR-3 delivery without actuator

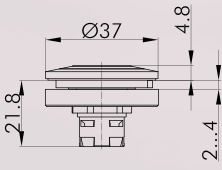
LED colour blue  **LR22K_24B_619**
 yellow  **LR22K_24Y_619**
 white  **LR22K_24W_619**
 red  **LR22K_24R_619**
 green  **LR22K_24G_619**

Accessories for Panel Mount Jacks

Illustration	Dimensions	Description	Type
		Connection Cable for LED light ring with open end, to connect the LED light rings to a voltage supply source, length approx. 80 cm, cross section 0.14 mm ²	VK_JST3_014
		RGB LED Light Ring for status indication or illumination - as an additional light signal - one-piece ring (360°) - rated voltage 24V AC (half-wave rectifier)/DC - up to 16.7 m colours are possible(colour mixing via PWM signal)	
		LED colour reed/green/blue	LR22K_24RGB_619
		Connection Cable for RGB-LED Light Ring with open end, to connect the RGB-LED light rings to a voltage supply source, length approx. 80 cm, cross section 0.14 mm ²	VK_LRR22_RGB
		Mounting Tool with torque limitation for the series QUARTEX-R(-JUWEL), KOMBITAST-R-JUWEL, RONDEX, RONDEX-M, RVA, DUX-Basic, SHORTRON, jacks of the RONTRON-R/-QJUWEL series	S22
		Mounting tool 16 with torque limitation for the series OKTRON, OKTRON-JUWEL, OKTRON-R, RONTRON-R-JUWEL, RONTRON-QJUWEL, QUARTRON, QUARTRON-JUWEL, RX-JUWEL	S16

About Us

Pushbuttons/Switches

Panel Mount Jacks

Emergency/Stop Buttons

Bus Technology

RFID

Enclosures

Pedal Switches

Terminal Blocks

Type Index

RONTRON-Q-JUWEL

Ø 22.3 mm

MADE IN GERMANY



Cutout dimensions

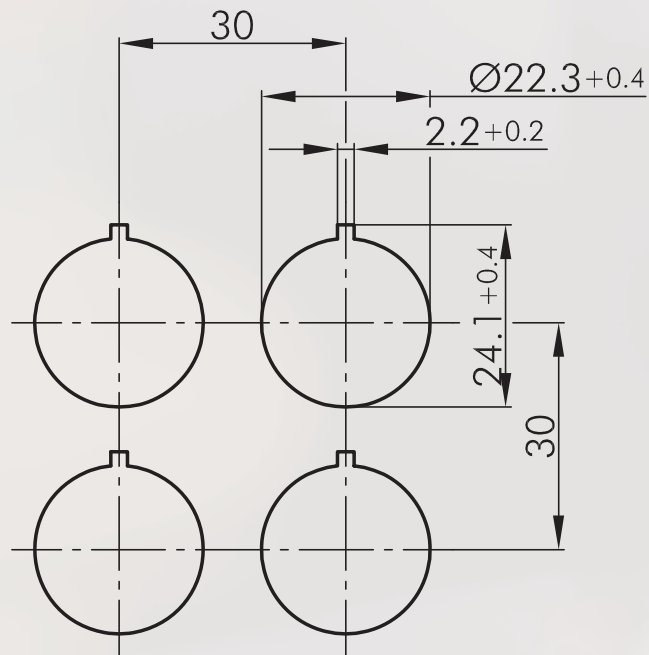

About Us

Pushbuttons/Switches

Panel Mount Jacks

Emergency-Stop Buttons

Bus Technology

RFD

Enclosures

Pedal Switches

Terminal Blocks

Type Index

Panel Mount Jacks

other cable lengths on request

Illustration

Dimensions

Description

Type

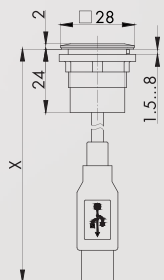

USB2.0 jack A/connector A (60 cm)

front:
USB2.0 jack type A
rear:
USB2.0 cable (length X=600 mm) with plug type A
Attention: Mounting position of the USB jack does not comply with the USB2.0 specification

front bezel: silver-coloured  **RQJ_USB**

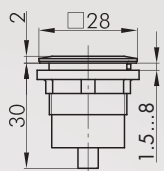

USB2.0 jack A/jack A

front:
USB2.0 jack type A
rear:
USB2.0 jack type A

front bezel: silver-coloured  **RQJ_USB_AA**

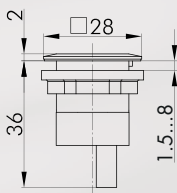

USB3.0 jack A/jack A

front:
USB3.0 jack type A
rear:
USB3.0 jack type A

front bezel: silver-coloured  **RQJ_USB3_AA**

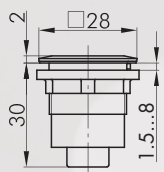

USB2.0 jack A/jack B

front:
USB2.0 jack type A
rear:
USB2.0 jack type B

front bezel: silver-coloured  **RQJ_USB_AB**

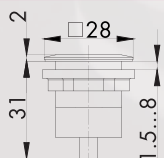

USB2.0 jack B/jack A

front:
USB2.0 jack type B
rear:
USB2.0 jack type A

front bezel: silver-coloured  **RQJ_USB_BA**

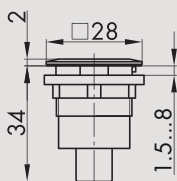

USB2.0 jack B/jack B

front:
USB2.0 jack type B
rear:
USB2.0 jack type B

front bezel: silver-coloured  **RQJ_USB_BB**

RONTRON-Q-JUWEL

Ø 22,3 mm

MADE IN GERMANY



About Us

Pushbuttons/Switches

Panel Mount Jacks

Emergency-Stop Buttons

Bus Technology

RFD

Enclosures

Pedal Switches

Terminal Blocks

Type Index

Panel Mount Jacks

Illustration	Dimensions	Description	Type
		front bezel: argenté	RQJ_FW6_STB
		RJ45 jack/connector (60 cm) front: RJ45 jack with screen rear: cable (length X=600 mm) with RJ45 plug with screen front bezel: silver-coloured	RQJ_RJ45
		RJ45 jack/jack front: RJ45 jack with screen rear: RJ45 jack with screen front bezel: silver-coloured	RQJ_RJ45_STB

Accessories

	IP40	Lead-sealable protective lid colour: transparent	KDP22RR
	IP65 IP67	Lead-sealable, robust, tight protective lid colour: transparent	KDPR22RR

Accessories for Panel Mount Jacks

Abbildung

Abmessungen

Beschreibung

Type



Mounting Tool

with torque limitation
for the series QUARTEX-R(-JUWEL), KOMBITAST-R-JUWEL, RONDEX,
RONDEX-M, RVA, DUX-Basic, SHORTRON, jacks of the RONTRON-
R/-Q-JUWEL series

S22

About Us

Pushbuttons/Switches

→ Panel Mount Jacks

Emergency/Stop Buttons

Bus Technology

RFID

Enclosures

Pedal Switches

Terminal Blocks

Type Index

About Us

Pushbuttons/Switches

→ Panel Mount locks

Emergency-Stop Buttons

Bus Technology

RFD

Enclosures

Pedal Switches

Terminal Blocks

Type Index

Cutout dimensions

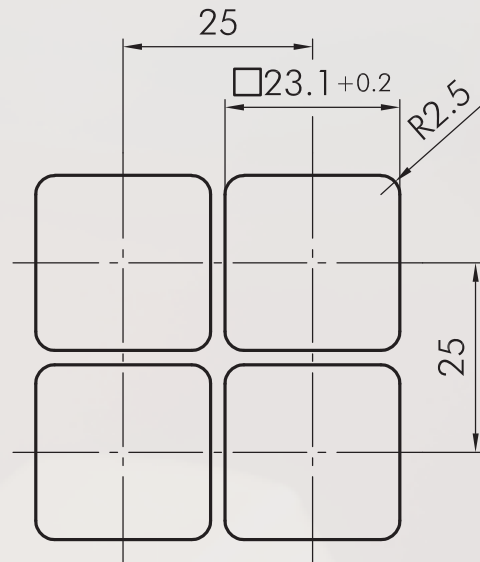

Panel Mount Jacks

other cable lengths on request

Illustration

Dimensions

Description

Type

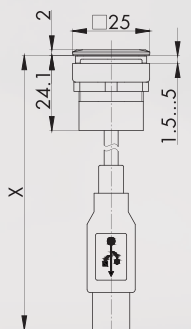

USB2.0 jack A/connector A (60 cm)

front:
USB2.0 jack type A
rear:
USB2.0 cable (length X=600 mm) with plug type A

front bezel: black  **OKJ_USB**

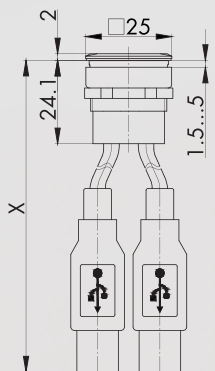

Double USB2.0 jack A/connector A (60 cm)

front:
2x USB3.0 jack type A
rear:
2x USB2.0 cable (length X=600 mm) with plug type A

front bezel: black  **OKJ_2USB**

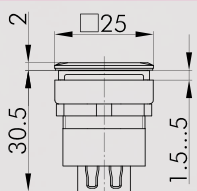

USB2.0 jack A/jack A

front:
USB2.0 jack type A
rear:
USB2.0 jack type A

front bezel: black  **OKJ_USB_AA**

Accessories

IP40



Protective lid

for pushbuttons and jacks of the OKTRON-JUWEL series

colour: transparent  **KDOKJ**



Mounting tool 22

with torque limitation
for the series QUARTEX-R(-JUWEL), KOMBITAST-R-JUWEL,
RONDEX, RONDEX-M, RONDEX-JUWEL, RVA, DUX-Basic,
SHORTRON, jacks of the ranges RONTRON-R/-Q-JUWEL

S22

About Us

Pushbuttons/Switches

Panel Mount Jacks

Emergency/Stop Buttons

Bus Technology

RFID

Enclosures

Pedal Switches

Terminal Blocks

Type Index

QUARTRON-JUWEL®

24 x 48 mm

MADE IN GERMANY

SCHLEGEL
ELEKTROKONTAKT

About Us

Pushbuttons/Switches

→ Panel Mount locks

Emergency-Stop Buttons

Bus Technology

RFD

Enclosures

Pedal Switches

Terminal Blocks

Type Index

Cutout dimensions

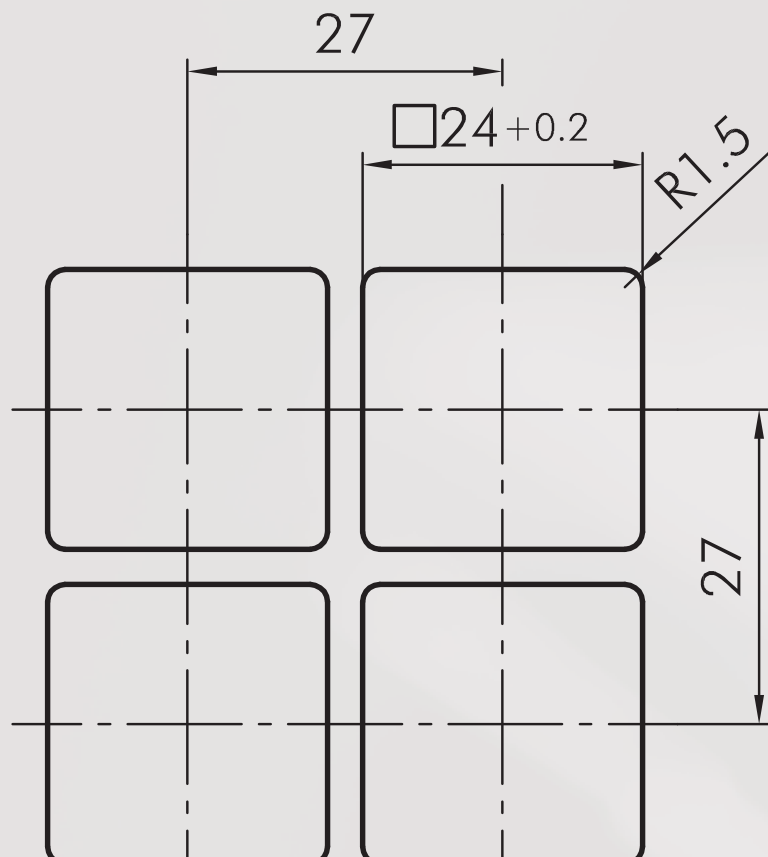

Panel Mount Jacks

other cable lengths on request

Illustration

Dimensions

Description

Type

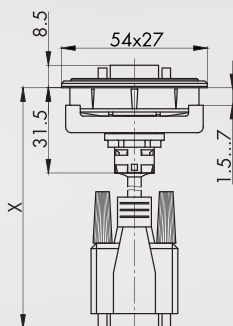

VGA jack/connector

front:
VGA jack
rear:
VGA -cable (length X=1000 mm) with connector

front bezel: black



LXJ_VGA_100CM

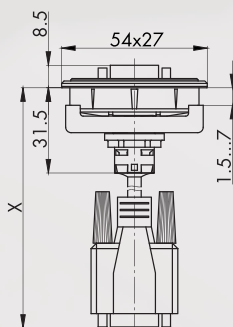

RS232 jack/connector

front:
RS232 jack
rear:
RS232 cable (length X=1000 mm) with connector
9-pole through-connected also suitable for RS485

front bezel: black



LXJ_RS232_100CM

Accessories



Mounting tool 16

S16

with torque limitation
for the series OKTRON, OKTRON-JUWEL, OKTRON-R,
RONTRON-R-JUWEL, RONTRON-Q-JUWEL, QUARTRON,
QUARTRON-JUWEL, RX-JUWEL

About Us

Pushbuttons/Switches

Panel Mount Jacks

Emergency/Stop Buttons

Bus Technology

RFID

Enclosures

Pedal Switches

Terminal Blocks

Type Index